

1 NO contact  
input bottom  
DC/UC coil

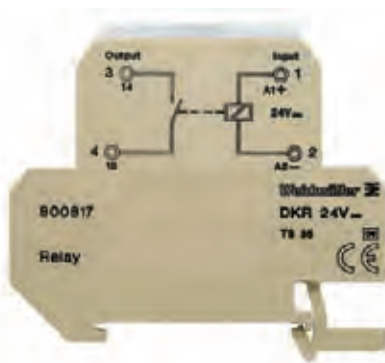

Relay modules and opto modules  
in 6 mm width

A

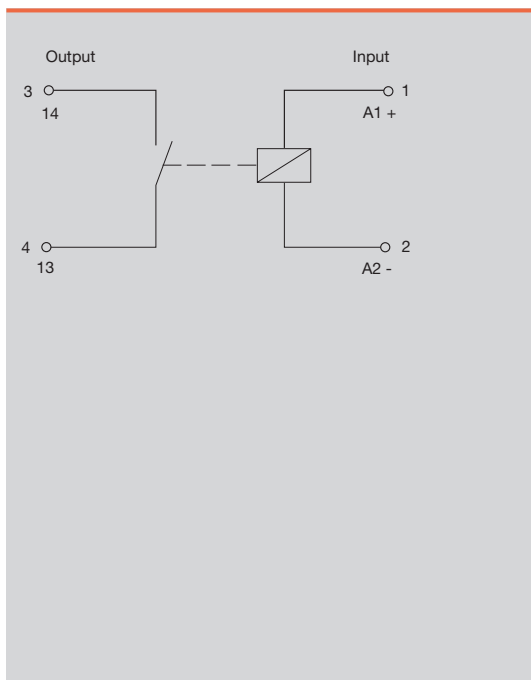

Output	
Switching voltage AC, max. / Continuous current	100 V / 0.5 A
min. switching capacity	1 V / 1 mA
Sparkover time / Drop-out time	typ. 0.7...2.5 ms / 0.2...2 ms
Contact material	Rh/Ru
Mechanical service life	10 <sup>9</sup> switching cycles
Max. switching frequency at rated load	200 Hz
Rated data	
Status indicator / Free-wheel diode	Green LED / Yes
Reverse polarity protection	Available
Ambient temperature (operational)	-25 °C...+40 °C
Storage temperature	-40 °C...+60 °C
Humidity	40°C / 93% rel. humidity, no condensation
Approvals	GOSTME25; CE
Insulation coordination (EN 50 178)	
Standards	EN 50178
Rated voltage	150 V
Impulse withstand voltage	1.5 kV
Clearance and creepage distances for control/load side	≥ 3 mm
Overvoltage category	III
Pollution severity	2
Protective separation acc. to VDE 0106 part 101	No
Dimensions	
Clamping range (nominal / min. / max.)	mm <sup>2</sup> 4 / 0.5 / 4
Length x width x height	mm 77 / 6 / 62
Note	
	End plate AP DKT4 PA 0687560000

Ordering data	5 V DC 1NO	12 V DC 1NO	24 V UC 1NO	24 V DC 1NO
<b>Input</b>				
Rated control voltage	5 V DC	12 V DC	24 V UC ±10 %	24 V DC +5 % / -10 %
Rated current AC			15 mA	
Rated current DC	5.5 mA	5.5 mA	9 mA	9.3 mA
Power rating	1.2 W	1.2 W	0.36 VA / 216 mW	225 mW
AC Response/dropout Volt			12 V / 8 V	
DC Response/dropout Volt	165 V / 22 V	165 V / 22 V	10 V / 11 V	11 V
AC pickup/dropout current			6.3 mA / 4.3 mA	
DC pickup/dropout current	11.8 mA	10 mA	3.8 mA // 3mA	7.5 mA

Ordering data				
For TS 32	Type		DKR 32 24VUC 1A	DKR 32 24VDC 1A
	Order No.		<b>8008110000</b>	<b>8016620000</b>
For TS 35	Type	DKR 35 5VDC 1A	DKR 35 12VDC 1A	DKR 35 24VDC 1A
	Order No.	<b>8019610000</b>	<b>8171100000</b>	<b>8016610000</b>

Ordering data				
<b>Note</b>				



**DK-SERIES - Relay modules**

**1 CO contact  
input bottom  
DC coil**

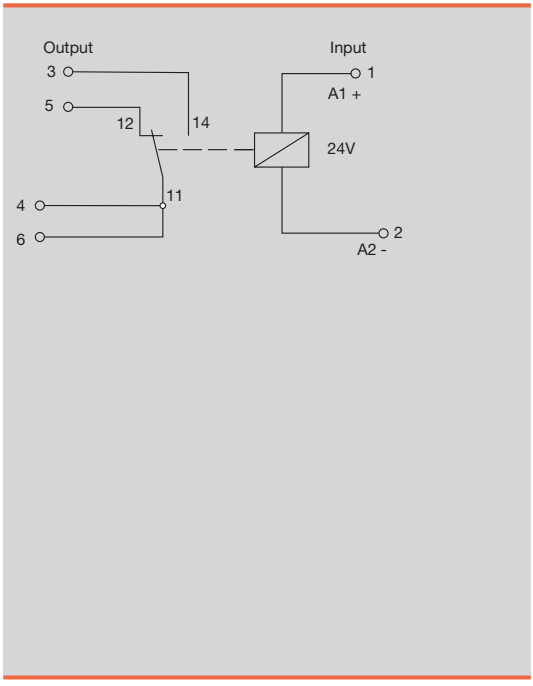
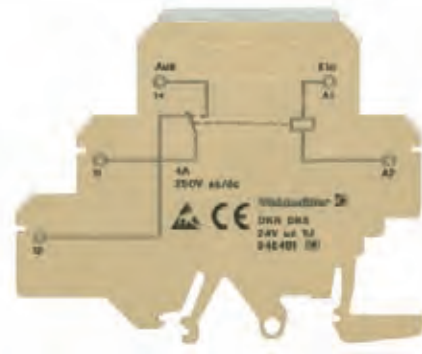

Output	
Switching voltage AC, max. / Continuous current	250 V / 6 A
min. switching capacity	12 V / 10 mA
Sparkover time / Drop-out time	6 ms / 15 ms AC; 8 ms DC
Contact material	AgSnO2
Mechanical service life	2*10 <sup>7</sup> switching cycles
Max. switching frequency at rated load	0.1 Hz
Rated data	
Status indicator / Free-wheel diode	Green LED / Yes
Reverse polarity protection	not available
Ambient temperature (operational)	-40 °C...+60 °C
Storage temperature	-40 °C...+60 °C
Humidity	40°C / 93% rel. humidity, no condensation
Approvals	GOSTME25; CE
Insulation coordination (EN 50 178)	
Standards	EN 50178
Rated voltage	300 V
Impulse withstand voltage	4 kV
Clearance and creepage distances for control/load side	≥ 8 mm
Overvoltage category	III
Pollution severity	2
Protective separation acc. to VDE 0106 part 101	No
Dimensions	
Clamping range (nominal / min. / max.)	mm <sup>2</sup> 4 / 0.5 / 4
Length x width x height	mm 77 / 6 / 62
Note	
	End plate AP DK5: 8268870000

**Ordering data**

**24 V UC 1CO**

Input	
Rated control voltage	24 V UC ±20 %
Rated current AC	9 mA
Rated current DC	7 mA
Power rating	220 mVA/ 180 mW
AC Response/dropout Volt	18 V
DC Response/dropout Volt	19 V
AC pickup/dropout current	7 mA
DC pickup/dropout current	-/5.5 mA

Ordering data	
For TS 32 / 35	Type DKR DK5 24VUC 1U
	Order No. <b>9454910000</b>
	Type
	Order No.

Ordering data	

Note	



1 CO contact  
input bottom  
DC coil

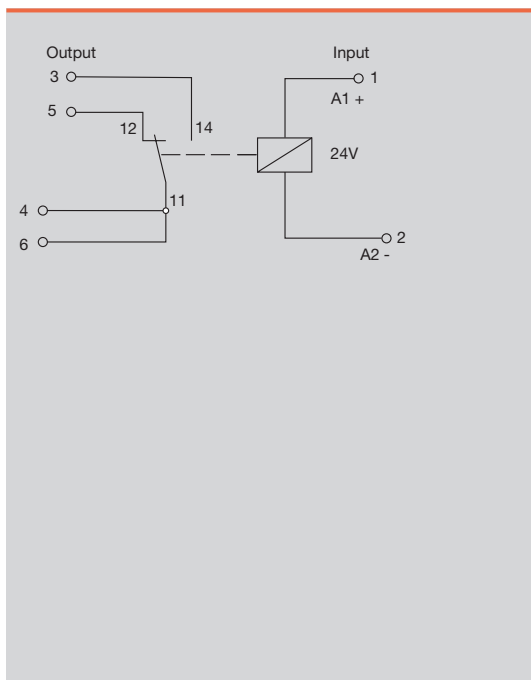

Output	
Switching voltage AC, max. / Continuous current	250 V / 6 A
min. switching capacity	10 V / 100 mA
Sparkover time / Drop-out time	typ. 0.7...2.5 ms / 0.2...2 ms
Contact material	AgNi 0.15 gold flashed
Mechanical service life	> 10 <sup>7</sup> switching cycles
Max. switching frequency at rated load	10 Hz
Rated data	
Status indicator / Free-wheel diode	Green LED / Yes
Reverse polarity protection	Available
Ambient temperature (operational)	-25 °C...+40 °C
Storage temperature	-40 °C...+60 °C
Humidity	40°C / 93% rel. humidity, no condensation
Approvals	GOSTME25; CE
Insulation coordination (EN 50 178)	
Standards	EN 50178
Rated voltage	300 V
Impulse withstand voltage	6 kV
Clearance and creepage distances for control/load side	≥ 8 mm
Overvoltage category	IV
Pollution severity	2
Protective separation acc. to VDE 0106 part 101	No
Dimensions	
Clamping range (nominal / min. / max.)	mm <sup>2</sup> 4 / 0.5 / 4
Length x width x height	mm 65 / 18 / 62
Note	
	End plate AP DKT4 PA 0687560000

Ordering data

24 V DC 1CO

Input	
Rated control voltage	24 V DC ±20 %
Rated current AC	
Rated current DC	11.5 mA
Power rating	384 mW
AC Response/dropout Volt	
DC Response/dropout Volt	19 V
AC pickup/dropout current	
DC pickup/dropout current	9 mA

Ordering data		
For TS 35	Type	DKR 35 24VDC 1U
	Order No.	8181980000
	Type	
	Order No.	

Ordering data		

Note		

## DK-SERIES - Opto modules

### Mini-coupler DKO

- Coupling of digital sensor/actuator signals between PLC and process
- Inexpensive solution for adapting level and potential
- Low input power
- Screw connection system
- 6 mm width
- For mounting on TS 35

### 5 V DC



### 12 V DC 10 kHz

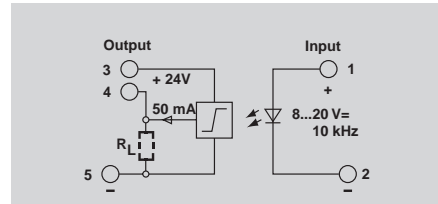
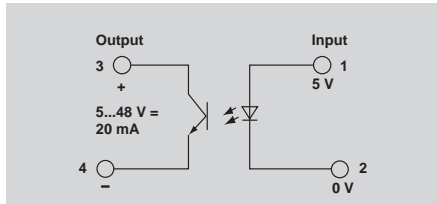

### Technical data

Control side	
Rated control voltage	5 V DC ±5 %
Power rating	50 mW
Input frequency	300 Hz
Rated auxiliary voltage	No
Status indicator	Green LED
Load side	
Rated switching voltage	5...48 V DC
Rated switching current	20 mA
Voltage drop at max. load	1.6 V
Switch-on delay / Switch-off delay	≤ 15 µs / ≤ 70 µs
Short-circuit-proof / Protective circuit	No / Diode
General data	
Ambient temperature (operational)	-25 °C...+40 °C
Storage temperature	-40 °C...+85 °C
Approvals	GOSTME25; CE
Insulation coordination (EN 50 178)	
Standards	EN 50178
Rated voltage	150 V
Rated impulse withstand voltage	4 kV
Clearance and creepage distances for control/load side	≥ 4 mm
Overvoltage category	III
Pollution severity	2

Rated control voltage	5 V DC ±5 %
Power rating	50 mW
Input frequency	300 Hz
Rated auxiliary voltage	No
Status indicator	Green LED
Rated switching voltage	5...48 V DC
Rated switching current	20 mA
Voltage drop at max. load	1.6 V
Switch-on delay / Switch-off delay	≤ 15 µs / ≤ 70 µs
Short-circuit-proof / Protective circuit	No / Diode
Ambient temperature (operational)	-25 °C...+40 °C
Storage temperature	-40 °C...+85 °C
Approvals	GOSTME25; CE
Standards	EN 50178
Rated voltage	150 V
Rated impulse withstand voltage	4 kV
Clearance and creepage distances for control/load side	≥ 4 mm
Overvoltage category	III
Pollution severity	2

Rated control voltage	8...20 V DC
Power rating	Max. 130 mW
Input frequency	Max. 10 kHz
Rated auxiliary voltage	No
Status indicator	Green LED
Rated switching voltage	24 V DC ± 10%
Rated switching current	50 mA
Voltage drop at max. load	≤ 1 V
Switch-on delay / Switch-off delay	1 µs / 2.5 µs
Short-circuit-proof / Protective circuit	No / Diode
Ambient temperature (operational)	-25 °C...+40 °C
Storage temperature	-40 °C...+85 °C
Approvals	GOSTME25; CE
Standards	EN 50178
Rated voltage	300 V
Rated impulse withstand voltage	6 kV
Clearance and creepage distances for control/load side	≥ 5.5 mm
Overvoltage category	III
Pollution severity	2

Dimensions	
Clamping range (nominal / min. / max.)	mm <sup>2</sup>
Length x width x height	mm
Note	

Screw connection	
4 / 0.5 / 4	
65 / 6 / 57	
Note	

Screw connection	
4 / 0.5 / 4	
65 / 12 / 57	
Note	

### Ordering data

Connection system	
For TS 35	
For TS 32	
Note	

Type	Qty.	Order No.
DKO 35 5VDC	10	8018630000
DKO 32 5VDC	10	8018620000
Note		
Input at bottom		

Type	Qty.	Order No.
DKO 35 12VDC 10KHZ	5	8184030000
Note		
Input at bottom		

### Accessories

End plate AP DKT 4: 0687560000
-----------------------------------

End plate AP DKT 4: 0687560000
-----------------------------------

End plate AP DKT 4: 0687560000
-----------------------------------

**Mini-coupler DKO**

- Coupling of digital sensor/actuator signals between PLC and process
- Inexpensive solution for adapting level and potential
- Low input power
- Screw connection system
- 6 mm width
- For mounting on TS 35

**24 V UC**



**24 V DC 3 kHz**

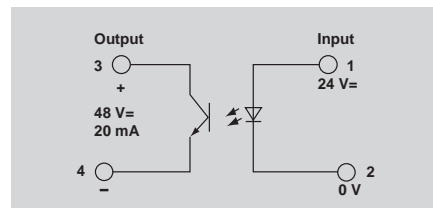
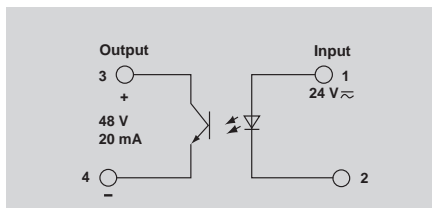

**Technical data**

Control side	
Rated control voltage	24 V UC ±10 %
Power rating	280 mVA / 230 mW
Input frequency	10 Hz at DC
Rated auxiliary voltage	No
Status indicator	Green LED
Load side	
Rated switching voltage	5...48 V DC
Rated switching current	20 mA
Voltage drop at max. load	≤ 1 V
Switch-on delay / Switch-off delay	≤ 15 ms at DC / ≤ 25 ms at DC
Short-circuit-proof / Protective circuit	No / Diode
General data	
Ambient temperature (operational)	-25 °C...+40 °C
Storage temperature	-40 °C...+85 °C
Approvals	GOSTME25; CE
Insulation coordination (EN 50 178)	
Standards	EN 50178
Rated voltage	300 V
Rated impulse withstand voltage	4 kV
Clearance and creepage distances for control/load side	≥ 4 mm
Overvoltage category	III
Pollution severity	2

Control side	
Rated control voltage	24 V UC ±10 %
Power rating	280 mVA / 230 mW
Input frequency	10 Hz at DC
Rated auxiliary voltage	No
Status indicator	Green LED
Load side	
Rated switching voltage	5...48 V DC
Rated switching current	20 mA
Voltage drop at max. load	≤ 1 V
Switch-on delay / Switch-off delay	≤ 15 ms at DC / ≤ 25 ms at DC
Short-circuit-proof / Protective circuit	No / Diode
General data	
Ambient temperature (operational)	-25 °C...+40 °C
Storage temperature	-40 °C...+85 °C
Approvals	GOSTME25; CE
Insulation coordination (EN 50 178)	
Standards	EN 50178
Rated voltage	300 V
Rated impulse withstand voltage	4 kV
Clearance and creepage distances for control/load side	≥ 4 mm
Overvoltage category	III
Pollution severity	2

Control side	
Rated control voltage	24 V DC ±10 %
Power rating	Max. 360 mW
Input frequency	3 kHz
Rated auxiliary voltage	No
Status indicator	Green LED
Load side	
Rated switching voltage	5...48 V DC
Rated switching current	20 mA
Voltage drop at max. load	≤ 900 mV
Switch-on delay / Switch-off delay	Approx. 50 µs / Approx. 80 µs
Short-circuit-proof / Protective circuit	No / Diode
General data	
Ambient temperature (operational)	-25 °C...+40 °C
Storage temperature	-40 °C...+85 °C
Approvals	GOSTME25; CE
Insulation coordination (EN 50 178)	
Standards	EN 50178
Rated voltage	300 V
Rated impulse withstand voltage	4 kV
Clearance and creepage distances for control/load side	≥ 4 mm
Overvoltage category	III
Pollution severity	2

Dimensions	
Clamping range (nominal / min. / max.)	mm <sup>2</sup>
Length x width x height	mm
Note	

Screw connection	
4 / 0,5 / 4	
65 / 6 / 57	
Note	

Screw connection	
4 / 0,5 / 4	
65 / 6 / 57	
Note	

**Ordering data**

Connection system	
For TS 35	
For TS 32	
Note	

Type	Qty.	Order No.
DKO 35 24VUC	10	8008150000
DKO 32 24VUC	10	8008090000
Note		
Input at bottom		

Type	Qty.	Order No.
DKO 35 24VDC 3KHZ E:U	10	8028300000
Note		
Input at bottom		

**Accessories**

End plate AP DKT 4: 0687560000
-----------------------------------

End plate AP DKT 4: 0687560000
-----------------------------------

End plate AP DKT 4: 0687560000
-----------------------------------



## DK-SERIES - Opto modules

### Mini-coupler DKO

- Coupling of digital sensor/actuator signals between PLC and process
- Inexpensive solution for adapting level and potential
- Low input power
- Screw connection system
- 6 mm width
- For mounting on TS 35

### 24 V DC 3 kHz



### 24 V DC 100 Hz

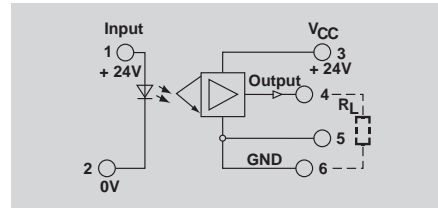
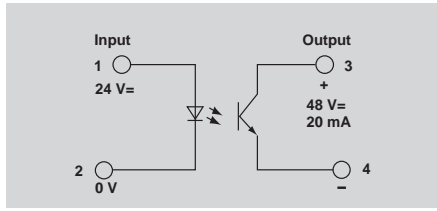
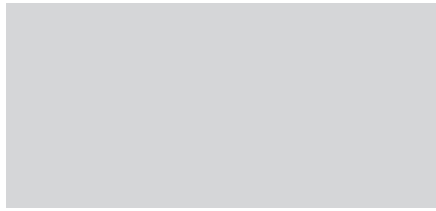
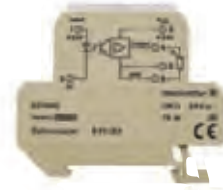

### Technical data

Control side	
Rated control voltage	24 V DC ± 10 %
Power rating	Max. 360 mW
Input frequency	3 kHz
Rated auxiliary voltage	No
Status indicator	Green LED
Load side	
Rated switching voltage	5...48 V DC
Rated switching current	20 mA
Voltage drop at max. load	≤ 900 mV
Switch-on delay / Switch-off delay	Approx. 50 µs / Approx. 80 µs
Short-circuit-proof / Protective circuit	No / Diode
General data	
Ambient temperature (operational)	-25 °C...+40 °C
Storage temperature	-40 °C...+85 °C
Approvals	GOSTME25; CE
Insulation coordination (EN 50 178)	
Standards	EN 50178
Rated voltage	300 V
Rated impulse withstand voltage	4 kV
Clearance and creepage distances for control/load side	≥ 4 mm
Overvoltage category	III
Pollution severity	2

Rated control voltage	24 V DC ± 10 %
Power rating	Max. 360 mW
Input frequency	3 kHz
Rated auxiliary voltage	No
Status indicator	Green LED
Rated switching voltage	5...48 V DC
Rated switching current	20 mA
Voltage drop at max. load	≤ 900 mV
Switch-on delay / Switch-off delay	Approx. 50 µs / Approx. 80 µs
Short-circuit-proof / Protective circuit	No / Diode
Ambient temperature (operational)	-25 °C...+40 °C
Storage temperature	-40 °C...+85 °C
Approvals	GOSTME25; CE
Standards	EN 50178
Rated voltage	300 V
Rated impulse withstand voltage	4 kV
Clearance and creepage distances for control/load side	≥ 4 mm
Overvoltage category	III
Pollution severity	2

Rated control voltage	24 V DC ± 10 %
Power rating	Max. 290 mW
Input frequency	100 Hz
Rated auxiliary voltage	No
Status indicator	Green LED
Rated switching voltage	24 V DC ± 10%
Rated switching current	2 A
Voltage drop at max. load	2 ms / < 7 ms
Switch-on delay / Switch-off delay	Yes / Varistor
Ambient temperature (operational)	-25 °C...+40 °C
Storage temperature	-40 °C...+85 °C
Approvals	GOSTME25; CE
Standards	EN 50178
Rated voltage	300 V
Rated impulse withstand voltage	4 kV
Clearance and creepage distances for control/load side	≥ 3 mm
Overvoltage category	III
Pollution severity	2

Dimensions	
Clamping range (nominal / min. / max.)	mm <sup>2</sup>
Length x width x height	mm
Note	

Screw connection	
4 / 0,5 / 4	
65 / 6 / 57	
Note	

Screw connection	
4 / 0,5 / 4	
65 / 12 / 57	
Note	

### Ordering data

Connection system	For TS 35
-------------------	-----------

Type	Qty.	Order No.
DKO 35 24VDC 3KHZ E:O	10	8215640000

Type	Qty.	Order No.
DKO 35 24VDC E:U	5	8181990000

Note	
------	--

Note	Input at top
------	--------------

Note	Input at bottom
------	-----------------

### Accessories

--

End plate AP DKT 4: 0687560000
-----------------------------------

End plate AP DKT 4: 0687560000
-----------------------------------

**Mini-coupler DKO**

- Coupling of digital sensor/actuator signals between PLC and process
- Inexpensive solution for adapting level and potential
- Low input power
- Screw connection system
- 6 mm width
- For mounting on TS 35

**24 V DC 200 Hz**



**24 V DC 200 Hz**

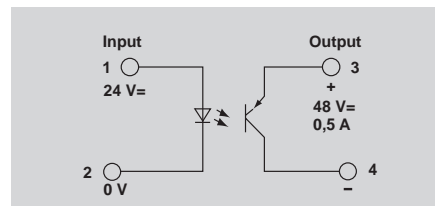
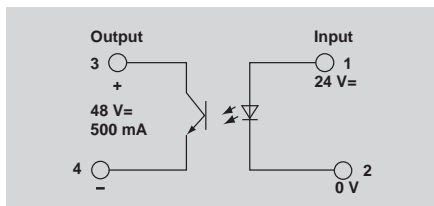

**Technical data**

Control side	
Rated control voltage	24 V DC ±10 %
Power rating	145 mW
Input frequency	200 Hz
Rated auxiliary voltage	No
Status indicator	Green LED
Load side	
Rated switching voltage	5...48 V DC
Rated switching current	500 mA
Voltage drop at max. load	≤ 800 mV
Switch-on delay / Switch-off delay	Approx. 40 µs / Approx. 65 µs
Short-circuit-proof / Protective circuit	No / Diode
General data	
Ambient temperature (operational)	-25 °C...+40 °C
Storage temperature	-40 °C...+85 °C
Approvals	GOSTME25; CE
Insulation coordination (EN 50 178)	
Standards	EN 50178
Rated voltage	300 V
Rated impulse withstand voltage	4 kV
Clearance and creepage distances for control/load side	≥ 4 mm
Overtoltage category	III
Pollution severity	2

Control side	
Rated control voltage	24 V DC ±10 %
Power rating	145 mW
Input frequency	200 Hz
Rated auxiliary voltage	No
Status indicator	Green LED
Load side	
Rated switching voltage	5...48 V DC
Rated switching current	500 mA
Voltage drop at max. load	≤ 800 mV
Switch-on delay / Switch-off delay	Approx. 40 µs / Approx. 65 µs
Short-circuit-proof / Protective circuit	No / Diode
General data	
Ambient temperature (operational)	-25 °C...+40 °C
Storage temperature	-40 °C...+85 °C
Approvals	GOSTME25; CE
Insulation coordination (EN 50 178)	
Standards	EN 50178
Rated voltage	300 V
Rated impulse withstand voltage	4 kV
Clearance and creepage distances for control/load side	≥ 4 mm
Overtoltage category	III
Pollution severity	2

Control side	
Rated control voltage	24 V DC ±10 %
Power rating	Max. 145 mW
Input frequency	200 Hz
Rated auxiliary voltage	No
Status indicator	Green LED
Load side	
Rated switching voltage	5...48 V DC
Rated switching current	500 mA
Voltage drop at max. load	≤ 800 mV
Switch-on delay / Switch-off delay	Approx. 40 µs / Approx. 65 µs
Short-circuit-proof / Protective circuit	No / Diode
General data	
Ambient temperature (operational)	-25 °C...+40 °C
Storage temperature	-40 °C...+85 °C
Approvals	GOSTME25; CE
Insulation coordination (EN 50 178)	
Standards	EN 50178
Rated voltage	300 V
Rated impulse withstand voltage	4 kV
Clearance and creepage distances for control/load side	≥ 4 mm
Overtoltage category	III
Pollution severity	2

Dimensions	
Clamping range (nominal / min. / max.)	mm <sup>2</sup>
Length x width x height	mm
Note	

Screw connection	
4 / 0,5 / 4	
65 / 6 / 57	
Note	

Screw connection	
4 / 0,5 / 4	
65 / 6 / 57	
Note	

**Ordering data**

Connection system	For TS 35
-------------------	-----------

Type	Qty.	Order No.
DKO 35 24VDC E:U	10	8019590000

Type	Qty.	Order No.
DKO 35 24VDC E:O	10	8215630000

Note	Input at bottom
------	-----------------

Note	Input at bottom
------	-----------------

Note	Input at top
------	--------------

**Accessories**

End plate AP DKT 4: 0687560000
-----------------------------------

End plate AP DKT 4: 0687560000
-----------------------------------

End plate AP DKT 4: 0687560000
-----------------------------------



## DK-SERIES - Opto modules

### Mini-coupler DKO

- Coupling of digital sensor/actuator signals between PLC and process
- Inexpensive solution for adapting level and potential
- Low input power
- Screw connection system
- 6 mm width
- For mounting on TS 35

### 24 V UC



### 48 V UC

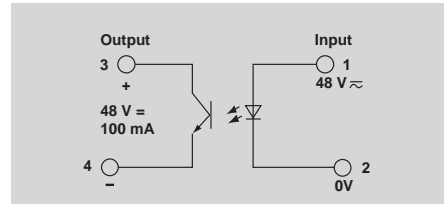
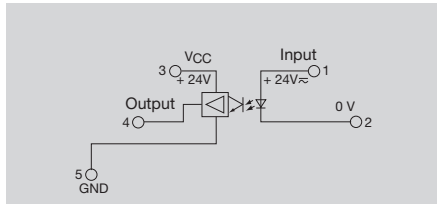
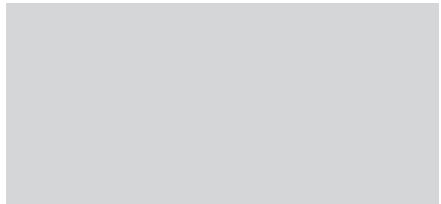

### Technical data

Control side	
Rated control voltage	24 V UC ±20 %
Power rating	Max.: 220 mVA / 195 mW
Input frequency	≤ 10 Hz
Rated auxiliary voltage	No
Status indicator	LED
Load side	
Rated switching voltage	24 V DC ±20%
Rated switching current	2 A
Voltage drop at max. load	
Switch-on delay / Switch-off delay	2 ms / < 7 ms
Short-circuit-proof / Protective circuit	Yes /
General data	
Ambient temperature (operational)	-25 °C...+50 °C
Storage temperature	-40 °C...+85 °C
Approvals	GOSTME25; CE
Insulation coordination (EN 50 178)	
Standards	EN 50178
Rated voltage	300 V
Rated impulse withstand voltage	6 kV
Clearance and creepage distances for control/load side	≥ 5.5 mm
Overvoltage category	III
Pollution severity	2

Rated control voltage	24 V UC ±20 %
Power rating	Max.: 220 mVA / 195 mW
Input frequency	≤ 10 Hz
Rated auxiliary voltage	No
Status indicator	LED
Rated switching voltage	24 V DC ±20%
Rated switching current	2 A
Voltage drop at max. load	
Switch-on delay / Switch-off delay	2 ms / < 7 ms
Short-circuit-proof / Protective circuit	Yes /
Ambient temperature (operational)	-25 °C...+50 °C
Storage temperature	-40 °C...+85 °C
Approvals	GOSTME25; CE
Standards	EN 50178
Rated voltage	300 V
Rated impulse withstand voltage	6 kV
Clearance and creepage distances for control/load side	≥ 5.5 mm
Overvoltage category	III
Pollution severity	2

Rated control voltage	48 V UC ±20 %
Power rating	Max.: 155 mVA / 135 mW
Input frequency	3 kHz
Rated auxiliary voltage	No
Status indicator	Green LED
Rated switching voltage	5...48 V DC
Rated switching current	100 mA
Voltage drop at max. load	≤ 1.5 V
Switch-on delay / Switch-off delay	< 5 ms / < 15 ms
Short-circuit-proof / Protective circuit	No / Diode
Ambient temperature (operational)	-25 °C...+50 °C
Storage temperature	-40 °C...+85 °C
Approvals	GOSTME25; CE
Standards	EN 50178
Rated voltage	300 V
Rated impulse withstand voltage	4 kV
Clearance and creepage distances for control/load side	≥ 4 mm
Overvoltage category	III
Pollution severity	2

Dimensions	
Clamping range (nominal / min. / max.)	mm <sup>2</sup>
Length x width x height	mm
Note	

Screw connection	
4 / 0,5 / 4	
77 / 6 / 62	
* Status indicator: green = OK, yellow = partial short circuit, blinking red = short circuit	

Screw connection	
4 / 0,5 / 4	
65 / 6 / 57	

### Ordering data

Connection system	
For TS 35	

Type	Qty.	Order No.
DKO DK5 24VUC	10	8228630000

Type	Qty.	Order No.
DKO 35 48VUC	10	8025910000

Note	

Input at bottom
-----------------

Input at bottom
-----------------

### Accessories

--

End plate AP DK 5 PA BE: 4036780000
--

End plate AP DK4 0687560000
--------------------------------



**Mini-coupler DKO**

- Coupling of digital sensor/actuator signals between PLC and process
- Inexpensive solution for adapting level and potential
- Low input power
- Screw connection system
- 6 mm width
- For mounting on TS 35

**115 V UC**



**230 V UC**

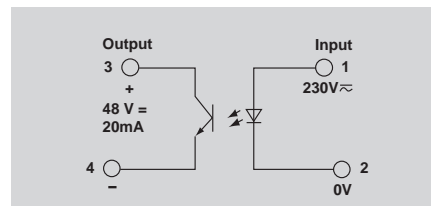
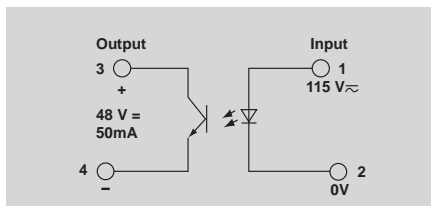
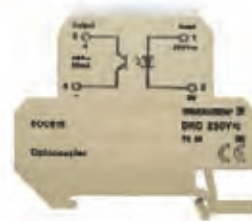

**Technical data**

Control side	
Rated control voltage	115 V UC +5 % / -15 %
Power rating	390 mVA / 350 mW
Input frequency	AC: 5 Hz / DC: 20 Hz
Rated auxiliary voltage	No
Status indicator	Green LED
Load side	
Rated switching voltage	5...48 V DC
Rated switching current	50 mA
Voltage drop at max. load	1.6 V
Switch-on delay / Switch-off delay	17.4 ms / 27.4 ms
Short-circuit-proof / Protective circuit	Yes / Diode
General data	
Ambient temperature (operational)	-25 °C...+40 °C
Storage temperature	-40 °C...+85 °C
Approvals	GOSTME25; CE
Insulation coordination (EN 50 178)	
Standards	EN 50178
Rated voltage	300 V
Rated impulse withstand voltage	6 kV
Clearance and creepage distances for control/load side	≥ 5.5 mm
Overvoltage category	III
Pollution severity	2

Control side	
Rated control voltage	115 V UC +5 % / -15 %
Power rating	390 mVA / 350 mW
Input frequency	AC: 5 Hz / DC: 20 Hz
Rated auxiliary voltage	No
Status indicator	Green LED
Load side	
Rated switching voltage	5...48 V DC
Rated switching current	50 mA
Voltage drop at max. load	1.6 V
Switch-on delay / Switch-off delay	17.4 ms / 27.4 ms
Short-circuit-proof / Protective circuit	Yes / Diode
General data	
Ambient temperature (operational)	-25 °C...+40 °C
Storage temperature	-40 °C...+85 °C
Approvals	GOSTME25; CE
Insulation coordination (EN 50 178)	
Standards	EN 50178
Rated voltage	300 V
Rated impulse withstand voltage	6 kV
Clearance and creepage distances for control/load side	≥ 5.5 mm
Overvoltage category	III
Pollution severity	2

Control side	
Rated control voltage	230 V UC +5 % / -15 %
Power rating	395 mVA / 370 mW
Input frequency	AC: 5 Hz / DC: 20 Hz
Rated auxiliary voltage	No
Status indicator	Green LED
Load side	
Rated switching voltage	5...48 V DC
Rated switching current	20 mA
Voltage drop at max. load	1.6 V
Switch-on delay / Switch-off delay	20 ms / 20 ms
Short-circuit-proof / Protective circuit	No / Diode
General data	
Ambient temperature (operational)	-25 °C...+50 °C
Storage temperature	-40 °C...+85 °C
Approvals	GOSTME25; CE
Insulation coordination (EN 50 178)	
Standards	EN 50178
Rated voltage	300 V
Rated impulse withstand voltage	6 kV
Clearance and creepage distances for control/load side	≥ 5.5 mm
Overvoltage category	III
Pollution severity	2

Dimensions	
Clamping range (nominal / min. / max.)	mm <sup>2</sup>
Length x width x height	mm
Note	

Screw connection	
4 / 0,5 / 4	
65 / 6 / 57	
Note	

Screw connection	
4 / 0,5 / 4	
65 / 6 / 57	
Note	

**Ordering data**

Connection system	
	For TS 35

Type	Qty.	Order No.
DKO 35 115VUC	10	8077860000

Type	Qty.	Order No.
DKO 35 230VUC	10	8008160000
DKO 32 230VUC	10	8008100000

Note	
	Input at bottom

Note	
	Input at bottom

Note	
	Input at bottom

**Accessories**

End plate	
	AP DKT 4: 0687560000

End plate	
	AP DKT 4: 0687560000

End plate	
	AP DKT 4: 0687560000

